

Miele

NOVOTRONIC

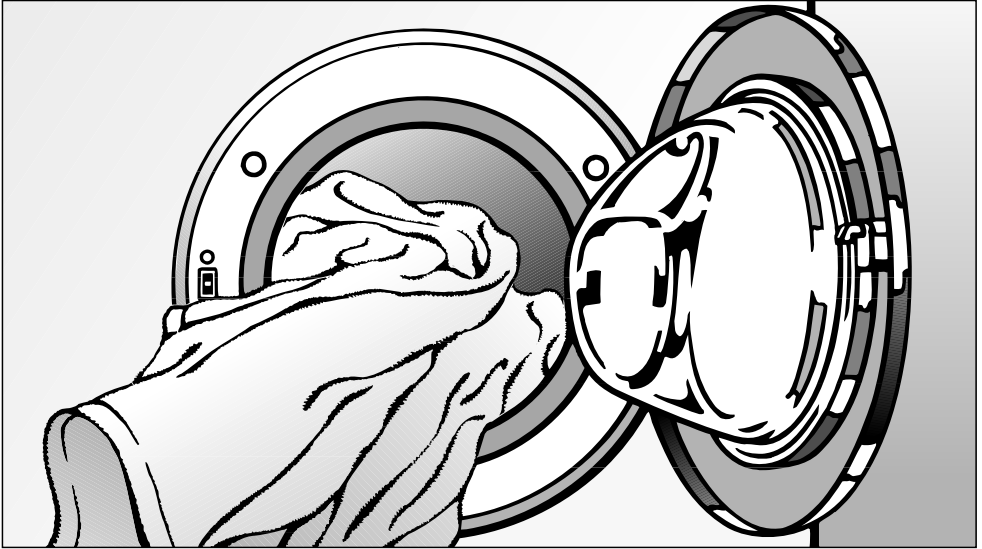

Operating instructions for washing machine W 919 WPS



It is **essential** to read these operating instructions before installing or using the machine, to avoid the risk of accident, or damage to the machine.



M.-Nr. 04 613 480

Contents

Guide to the machine	3
Warning and Safety Instructions	5

Preparation for use

Help to protect our environment	8
Installation	36
Plumbing	39
Electrical connection	43

Operating

Washing environmentally and economically	9
Before using for the first time	10
Brief guide to correct washing	11
Changing the programme sequence	14
Adding or removing washing	15
Adding detergent	16
Fabric conditioners/starch formulations	17
Programme selection	18
Programme sequence	20
Care symbols	22
Additional options	23
Delay start/Time left indicators	25

Maintenance

Cleaning and care	26
Problem solving guide	30
After sales service	35

Programmable functions

Programmable functions - Selection	44
Programmable functions - To programme	45
Programmable functions - Check/Cancel	46

Consumption data	47
-----------------------------------	----

Technical data	48
---------------------------------	----

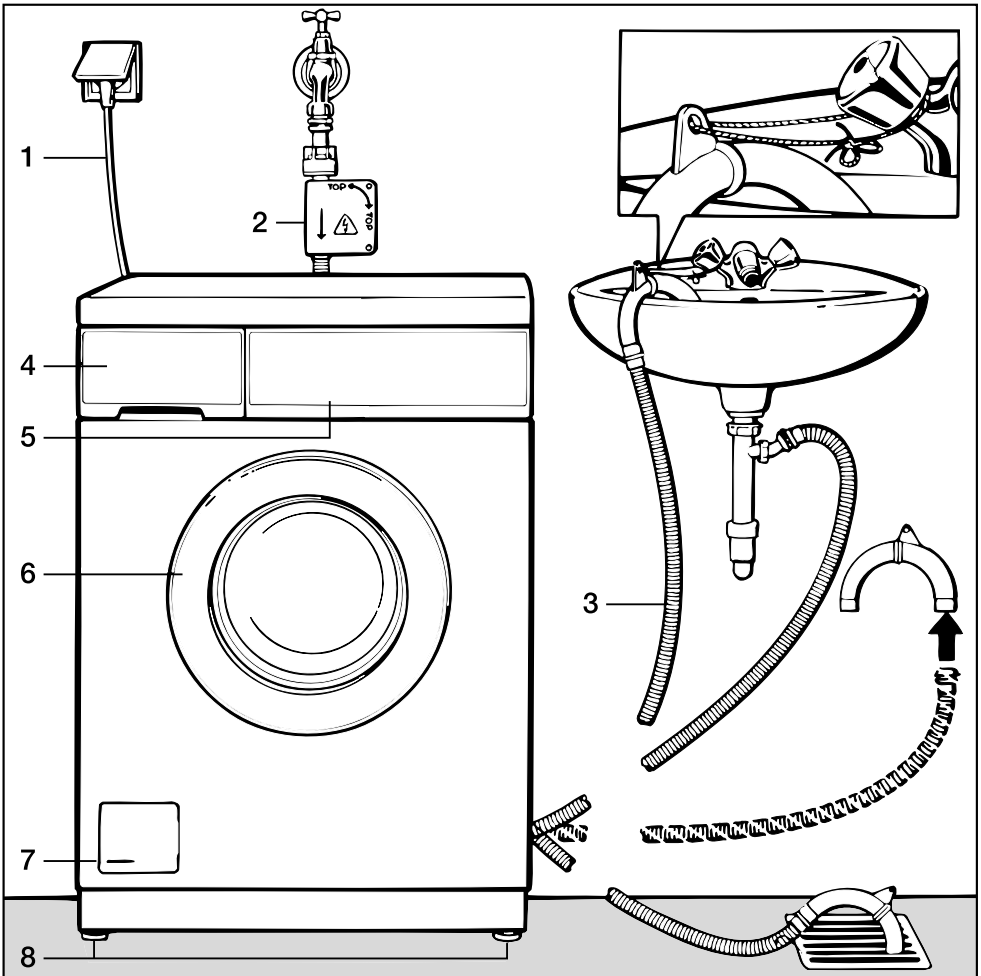

- | | |
|--|---|
| 1 Electric supply cable | 5 Facia panel with controls |
| 2 Inlet hose with "Waterproof System" | 6 Drum door |
| 3 Flexible drain hose (with detachable swivel elbow) | 7 Panel for access to fluff filter, drain pump and emergency door release |
| 4 Detergent dispenser drawer | 8 Four height adjustable feet |

Guide to the machine

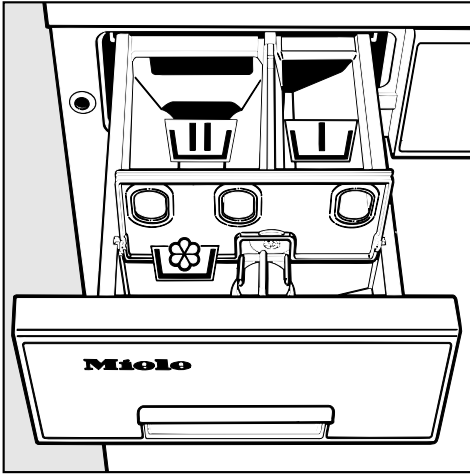

Detergent dispenser drawer

Compartment - Pre-wash

Compartment - Main wash

Compartment (with lid) -Conditioner

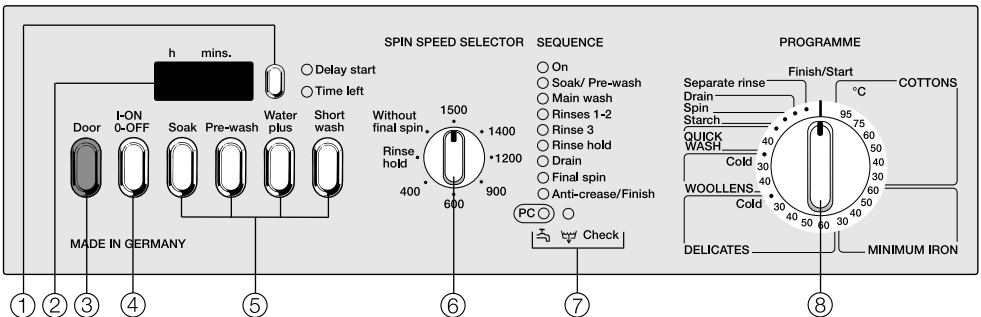

- ① "Delay start" button
- ② Time display "h min"
- ③ "Door pushbutton opens the drum door
- ④ "I - ON / O - OFF" button switches the machine on or off or interrupts a programme
- ⑤ Pushbuttons for additional options
- ⑥ Spin speed selector
- ⑦ Programme sequence indicator and control lights
- ⑧ Programme selector

Warning and Safety Instructions

Read the operating instructions before using this machine for the first time. They contain important information about the safety, use and maintenance of the machine. This will avoid the risk of accidents and damage to the machine. Keep these operating instructions in a safe place and ensure that new users are familiar with the content. Pass them on to any future owner of the machine.

Correct usage

Only use the washing machine to wash items which are declared by the manufacturer to be machine-washable on the wash-care label. Any other applications may be dangerous. The manufacturer is not liable for damage resulting from improper use or operation.

This appliance should not be operated by children. Supervise its use by the elderly or infirm.

Technical safety

Before setting up the machine, check it for any externally visible damage. Do not install and use a damaged machine.

Before connecting the machine, ensure that the connection data on the data plate (fusing, voltage and frequency) matches the mains electricity supply. If in any doubt, consult a qualified electrician.

The electrical safety of this machine can only be guaranteed when continuity is complete between the machine and an effective earthing system which complies with local and national regulations. It is most important that this basic safety requirement is regularly tested by a qualified electrician.

The manufacturer cannot be held responsible for the consequences of an inadequate earthing system.

For safety reasons do not operate this appliance on an extension cable. Danger of overheating.

The machine is built in accordance with current safety requirements. Unauthorised repairs could result in unforeseen dangers for the user, for which the manufacturer cannot accept responsibility. Repairs should only be undertaken by a Miele approved engineer.

The machine is only completely isolated from the electricity supply when:

- it is switched off at the wall socket and the plug is withdrawn, or
- it is switched off at the mains, or
- the mains fuse is withdrawn.

Warning and Safety Instructions

■ The Miele “Waterproof system” protects from water damage provided the following conditions have been met:

- the machine is correctly plumbed in and connected to the electricity supply.
- if a fault has been identified, the machine must be examined by a competent person before further use and repaired if necessary.

■ Faulty components must only be exchanged for Miele original spare parts. Only when these parts are fitted can the safety standards of the machine be guaranteed.

Use

■ Do not install your washing machine in rooms where temperatures below freezing may occur. Frozen hoses may burst under pressure. The reliability of the electronic control system may be impaired at temperatures below freezing point.

■ In countries where there are areas which may be subject to infestation by cockroaches or other vermin, pay particular attention to keeping the appliance and its surroundings in a clean condition at all times. Any damage which may be caused by cockroaches or other vermin will not be covered by the appliance guarantee.

■ Before using the machine for the first time, check that the transit fitting at the rear of the machine has been removed (see section on “Installation”). During spinning, a transit fitting which is still in place may result in damage to both the machine and adjacent furniture or appliances.

■ Turn off the stopcock if the machine will be left for any length of time (e.g. holiday), especially if there is no floor drain (gully) in the immediate vicinity.

■ **Flooding danger.**
If hooking the drain hose into a wash basin, check that the water can drain off quickly enough to prevent the sink from overflowing. Make sure the drain hose is secure, so that the force of the water flowing out of the hose does not dislodge it. Otherwise this will result in flooding.

■ Take care to ensure that foreign objects (e.g. nails, needles, coins, paper clips, etc.) do not find their way into the machine with the washing (e.g. in pockets). Foreign objects can damage components of the machine, which in turn can result in damage to the washing.

Warning and Safety Instructions

■ If the correct amount of detergent is dispensed, the machine should not need to be descaled. If, however, you do wish to descale the machine only use proprietary non-corrosive descaling agents and strictly observe the instructions. Consult the Miele Customer Service Department.

■ Textiles which have been pre-treated in solvent based cleaning agents must be thoroughly rinsed in clean water before being washed in the machine.

■ Never use solvent based cleaning agents in this machine, as this may result in damage to component parts and create toxic fumes. Such detergents also pose a fire and explosion hazard.

■ Only use dyes specified by the manufacturer as being suitable for use in a washing machine. Always observe the manufacturer's instructions carefully.

■ Dye removers may contain sulphur compounds which cause damage such as corrosion to the machines. Do not use dye removers in this machine.

■ For machines with a 'porthole' door, remember that the porthole glass will be hot when washing at very high temperatures. Do not let children touch it during a hot wash programme.

■ Always make sure the drum is stationary before reaching in to remove washing. Reaching into a moving drum is extremely dangerous.

Accessories

■ Accessory parts may only be fitted when expressly approved by Miele. If other parts are used, guarantee, performance and product liability claims may be invalidated.

Disposal of your old machine

■ Before discarding an old machine unplug it. Render the plug useless. Cut off the cable directly behind the appliance to prevent misuse.

Help to protect our environment

Disposal of the packing material

The transport and protective packing is mostly manufactured from the following recycled or re-useable materials:

- corrugated paper/card
- polystyrene - CFC-free
- untreated surplus wood
- chipboard, contains no phenolic resins
- polyethylene foil (PE)
- packaging straps: polypropylene (PP)

Rather than just throwing these materials away, please take them to the nearest local authority collection point for specific waste.

Disposal of your old machine

Old machines may contain material which can be reclaimed or recycled. Please contact your dealer, your local waste collection centre or scrap merchant about potential recycling schemes.

Ensure that the machine presents no danger to children while being stored for disposal.

See the appropriate section in the Warning and Safety instructions.

Washing environmentally and economically

Caring for the environment means saving water, energy and detergent when washing but without compromising on results.

The key to a good wash result is finding the best combination of amount of detergent, temperature, length of programme and the machine's technology.

If necessary, some programmes take longer to achieve this effect. With the "Hydromatic" system, the drum can revolve at different speeds. Longer and slower action together with pauses for steeping, work towards a good result.

The automatic load control facility ensures the correct water level for the type of fabric and laundry load being washed. Sometimes it even appears that there is no water in the drum.

Normally, main wash is sufficient for a clean result, so a pre-wash is not automatically included in the programmes. If it is wanted, a simple press on the pre-wash selector includes it.

Economy tips

To help you wash most economically, remember the following tips:

- The automatic load control facility allows you to wash individual loads of between 1 and 5 kg. Ideally wash with the maximum load specified for each programme. This uses the energy to the best advantage.
- Only use the correct amount of detergent required for the water hardness level in your area, according to the detergent manufacturer's recommendations.
- If washing is not heavily stained, select a lower temperature setting than indicated on the wash care label but do not additionally select "Short".
- Use the "Short wash" option for washing that is only very lightly soiled, but do not additionally reduce the temperature.
- Using the additional "Soak" option allows you to reduce the temperature used in the main wash.

Before using for the first time

Flush out any residual test water still in the machine as follows:

- Do not load the machine.
- Add a little detergent to compartment **II**.
- Switch on the machine.
- Press the “Short wash” selector.
- Select the “COTTONS 60°C” programme.
- This operation will flush out any residues.

Water hardness reminder

- The amount of detergent will depend on various factors including the water hardness level in your area. The dial located in the detergent dispenser box can be turned to the relevant setting as a water hardness reminder, (using 1 = soft, 4 = very hard).

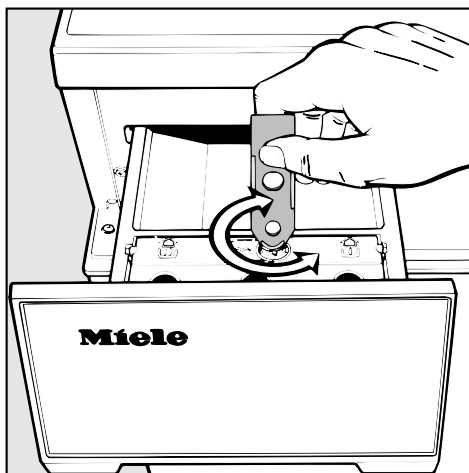

- Use the spatula supplied with the machine. It is located at the rear of the dispenser drawer.

If you do not know how hard the water is in your catchment area, please contact your local water authority.

Brief guide to correct washing

The headings numbered (1, 2, 3, ...) offer a brief step by step guide to the operating sequence.

Before washing

1 Prepare the wash load

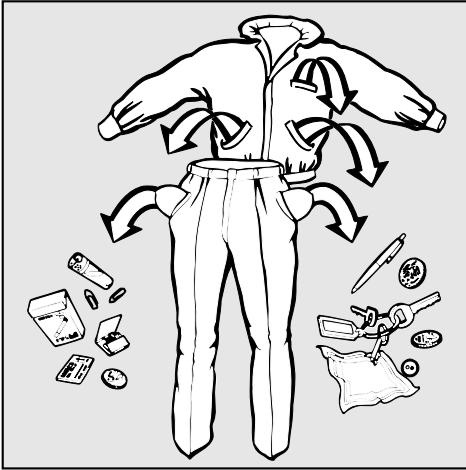

- Empty all pockets.

Foreign objects (e.g. nails, coins, paper clips etc) can cause damage to textiles and components in the machine.

- Sort the washing

Most textiles have a care label in the collar or side seam. Sort the washing by care label symbols. (See Symbols chart). Only wash items in this machine which are declared by the manufacturer as being machine washable on the textile care label.

Dark textiles often contain excess dye and should be washed separately several times before being included in a mixed load.

Delicate textiles should be washed separately in a delicates programme.

Only wash textiles made from wool or wool mixtures if the textile care label states that they are suitable for machine washing.

- Pre-treating the washing
Badly soiled areas, e.g. collars and cuffs, and water soluble stains can be pre-treated with bar soap, liquid detergent or detergent mixed into a solution or paste.

With particularly stubborn stains ask your Dry Cleaner for advice. Do not use solvent based cleaning agents in this machine.

2 Open the door

Brief guide to correct washing

3 Load the drum

Unfold washing and load loosely in the drum. To achieve best results it is advisable to make up mixed loads consisting of both large and small items.

This improves the washing effect and helps distribute the load evenly during spin.

Overloading reduces the wash result and causes more creasing.

Please note maximum load weights:

COTTONS 5.0 kg

MINIMUM IRON 2.5 kg

DELICATES/SYNTHETICS 1.0 kg

WOOL 1.0 kg

QUICK WASH 40°C 2.5 kg

Curtains:

Remove lead weights and strips or place in a laundry bag.

Any loose wiring in bras etc., should be removed or sewn in.

Woollens, knitted garments, T-shirts etc:

Turn inside out, if the manufacturer recommends it.

4 Close the drum door.

Make sure that no items of washing are caught between the door and the door seal.

5 Turn on the stopcock (if it is not already on)

6 Add detergent.

See Section on Detergent for details.

To start a programme

1 Turn the programme selector to "Finish/Start".

2 Press the "I-ON / O-OFF button.

3 Press buttons for additional options if required

(See Section on Additional options).
See "Delay start / Time left display" Section if required

4 Select the spin speed.

(See Section on Additional options).

5 Turn the programme selector to the wash programme desired.

The programme selector can be turned to the left or the right.

After washing

- 1 Turn the programme selector to "Finish/Start".
- 2 Press the "Door" button.

Only remove washing from the machine once the drum has stopped turning, otherwise you may seriously injure yourself.

- 3 Press the I-ON / O-OFF button.
- 4 Remove the washing.

Make sure the drum is empty. Items left behind could shrink or colour run in the next wash.

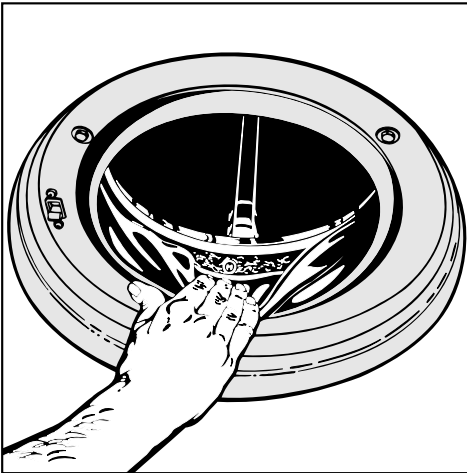

- 5 Check the folds in the door seal for buttons etc.

6 Close the drum door

Otherwise there is a danger of objects being placed inadvertently in the drum. If these remained unnoticed and were washed in the next load, they could damage the washing.

Changing the programme sequence

Stopping a programme

- Turn the programme selector to “Finish/Start”.

Interrupting a programme

- Press the “I-ON/O-OFF” button.

To continue the programme, switch the machine back on.

Changing an incorrectly selected programme:

- Turn the programme selector to “Finish/Start”.

A new programme can be selected when only the “ON” indicator light is still on.

Changing a programme which has been locked, see Section on Activating programmable functions.

To omit a programme stage.

- Turn the programme selector to “Finish/Start”

As soon as the programme sequence light for the stage at which the programme should continue starts flashing:

- Turn the programme selector switch to the appropriate programme **within 3 seconds**.

Adding or removing washing

Washing can be added or removed after the programme has already started, when using the following programmes:

- COTTONS
- MINIMUM IRON
- QUICK WASH 40°C
- WOOLLENS
- Starch
- Press the “Door” button in and hold it until the door springs open.
- Add or remove items of washing.
- Press any option buttons that had previously been selected.
- Shut the door.

COTTONS and QUICK WASH 40°C

The door can be opened in the following programme stages:

- Main wash
- Rinses

Please note that the door can only be opened when the suds temperature is less than **55°C**.

MINIMUM IRON and WOOLLENS

The door can be opened during the following programme stage:

- Main wash

Washing cannot be added or removed later if the following additional options or programmable functions have been selected:

- “Water plus” (the water level is increased)
- Programme lock (e.g. to prevent children from opening the door during the wash cycles).

Adding detergent

All modern detergents produced for automatic washing machines are suitable, including liquid, compact (concentrated) and special application detergents. Use dispensing aids, e.g. balls, if these are supplied with the detergent. Woollens and knitwear containing wool mixtures should be washed using a detergent specifically designed for washing woollens. Amounts of detergent are recommended on the packaging. The right amount to dispense will depend on the following:

- The quantity of the washing.
- The water hardness level (check with your local water supplier).
- The level of soiling.

Water Hardness

Hardness range	Type of water (hardness)	Total hardness (mg/l)	°dH (German)
I	soft	0 - 130	0° - 7°
II	medium	130 - 250	7° - 14°
III	hard	250 - 380	14° - 21°
IV	very hard	over 380	over 21°

It is important to dispense the correct amount, because...

...too little has the following results:

- The washing will not be properly clean and will in time become grey and hard to the touch.
- Greasy particles cling to the washing.
- Lime deposits on the heater elements.

...too much results in the following:

- Excessive foam.
- Low level of agitation.
- Poor washing and rinsing results.

Water is taken in through compartment **U** in the pre-wash.

Water is taken in through compartment **U** in the main wash. If the capacity of compartment **U** is insufficient for the amount of detergent needed (e.g. in very hard water areas), the Customer Service Engineer can adjust the machine so that water and detergent can also be taken into the main wash through compartment **U**.

Water Softeners

A water softener can be used to cut down on the use of detergents in water hardness ranges II-IV. Dispense according to the amount specified on the packaging. First add detergent and then the water softener.

Use a quantity of detergent as for soft water.

If you wash using several components (e.g. special application detergents), we recommend dispensing the agents into compartment **U** in the following order:

1. Detergent
2. Water softener
3. Stain salts

This way the agents are distributed more efficiently.

Fabric conditioners/Texturisers

Fabric conditioners make garments soft and fluffy to handle and help prevent static cling when tumble drying. Dispense according to the manufacturer's instructions.

Texturisers are synthetic starch formulations and give body to items e.g. shirts, tablecloths and bed linen.

- Open the lid of compartment .

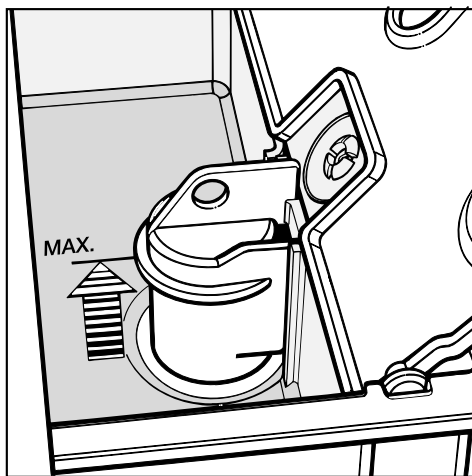

- Add fabric conditioner, **but do not exceed the max. level mark.**
- Close the compartment lid and push the drawer back in.
- The conditioner is automatically dispensed in the last rinse. At the end of the programme a small amount of water remains in the fabric conditioner compartment .
- If preferred, turn the spin speed selector to "Rinse hold" to allow the load to steep in the fabric conditioner / retexturiser.

Starch / liquid starch

- Prepare and dispense the starch solution in accordance with the manufacturer's instructions.
 - Add to compartment .
 - Select the spin speed.
 - Turn the programme selector to "Starch".
 - The "Soak / Pre-wash" indicator will light up.
 - If the washing is not to be spun at the end of the programme after starching, turn the spin speed selector to "without final spin". Water will be drained away at the end of the starch stage.
 - If the washing is to be steeped in water after the starch stage (to lessen creasing), turn the spin speed selector to "Rinse hold".
- To continue:**
Select a spin speed.

Programme selection

Programme	Fabric	Temperature range
COTTONS 	cottons and linen fabrics eg bedlinen, table linen, towelling, jeans, T-shirts and nappies.	95°C bis 30°C
MINIMUM IRON 	(60°C) white nylon white polyester fabrics, (50°C) coloured nylon, polyester, cotton and viscose fabrics with special finishes, acrylic cotton fabrics, coloured polyester / cotton fabrics (40° / 30°C) minimum iron fabrics not washable at higher temperatures, (60 - 30°C).	60°C to 30°C
DELICATES 	Acrylics acetate and triacetate, socks and stockings in man-made fibres (not wool or wool blends),	60°C to cold
	Curtains declared machine-washable by the manufacturer (pre-wash probably advisable)	30°C to cold
WOOLLENS	Programme for machine-washable wool fabrics bearing the machine-washable care label (there is not a pre-wash option) (See Care Symbol Chart)	40°C to cold
QUICKWASH 40°C 	Very lightly soiled fabrics Not suitable for Delicates	40°C
Starch	Table cloths, napkins, overalls, uniforms.	cold
Spin	Articles which can be spun, eg handwashed items	
Drain	For use when the cycle stops at "Rinse hold" and the washing is not to be spun	
SEPARATE RINSE	Articles which should be washed by hand and only rinsed and spun in the machine.	cold

Programme selection

Max. load	Additional options	Notes
5 kg	<ul style="list-style-type: none"> – Soak – Pre-wash – Water plus – Short wash 	with heavily soiled items select "Soak" or "Pre-wash"
2,5 kg	<ul style="list-style-type: none"> – Soak – Pre-wash – Water plus – Short wash 	<p>with heavily soiled items select "Soak" or "Pre-wash"</p> <p>for lightly soiled items select Short wash"</p>
1 kg	<ul style="list-style-type: none"> – Soak – Pre-wash – Short wash 	<p>Use the Wool programme for textiles with wool content.</p> <p>If "cold" is selected for the temperature, the water is warmed to 24°C. This helps the effect of the detergent.</p> <p>For shorter programmes use Delicates + Short wash and not "QUICKWASH 40°C"</p>
Fill the drum loosely 1/2 to 3/4 full	<ul style="list-style-type: none"> – Soak – Pre-wash – Short 	Dust in curtains usually makes pre-wash advisable
1 kg		If "cold" is selected for the temperature, the water is warmed to 24°C. This helps the effect of the detergent
2,5 kg	– Water plus	Add less detergent (half load)
5 kg		The washing should be washed but not treated with fabric conditioner.
5 kg		
5 kg		

See Section on Additional options for more details, and also Section on Programmable functions.

Programme sequence

	COTTONS	MINIMUM IRON	DELICATES
Soak	optional	optional	optional
Pre-wash	optional	optional	optional
Main wash	●	●	●
Top-up rinse	from 75°C	–	–
Graduated rinsing	–	from 50°C	from 50°C
No. of rinses – normal	3 oder 4 ¹⁾	3	3
– part load	2	3	3
– short wash	2	2	3
Rinse & interim spin (rpm)	max. 1000	max. 500	–
Final spin (rpm)	max. 1500	max. 900	max. 600
Anti-crease spin & loosen	max. 30 mins	max. 30 mins	max. 30 mins
Rinse hold	optional	optional	optional
Without final spin	optional	optional	optional
Wash rhythm	normal	normal	gentle action
Water level – Wash	low ²⁾	low ²⁾	high
– Rinse	low ²⁾	medium ²⁾	high

Notes:

- programme section available
- Programme section not available

1) **A 4th rinse** automatically switches in if there is too much foam in the drum, or if a spin speed lower than 800 rpm has been selected.

2) Increasing the water level:

The water level can be increased from a low level to a higher level by pressing the “Water plus” button.

Top-up rinse:

Additional water flows into the drum, and the suds are cooled slightly. Hot water might damage plastic drain pipes.

Graduated rinsing:

The suds are cooled at the end of the wash cycle by water flowing in and being pumped away at intervals. This minimises the danger of creasing, by avoiding sudden temperature changes.

WOOLLENS:

Wool is susceptible to damage from movement when it is wet. Drum movement times during the programme are shorter, and the drum rotates more slowly.

Programme sequence

WOOLLENS	QUICKWASH 40°C	Starch	Spin	Separate rinse
–	–	–	–	–
–	–	●	–	–
●	●	–	–	–
–	–	–	–	–
–	–	–	–	–
3	2	–	–	2
3	2	–	–	–
–	–	–	–	–
–	max. 500	–	–	–
max. 900	max. 1500	max. 1500	max. 1500	max. 900
–	max. 30 min	max. 30 min	max. 30 min	–
optional	optional	optional	–	optional
optional	optional	optional	–	optional
Wool	normal	normal	–	–
medium	low ²⁾	low	–	–
high	medium	–	–	high

Interim spin:

There is a spin between the rinses.

Final spin:









The maximum spin speed according to the programme is held constant for a fixed period of time. In the programmes MINIMUM IRON, WOOL and Separate Rinse the spin speed is automatically limited to 900 rpm and in the DELICATES programme to 600 rpm, even if the selector has been set to a higher spin speed. A lower speed can be selected.

Anti-crease action:

Guards against the tendency for creases to set in when fabrics have been left in water for a long time. There is drum movement twice a minute.

Care symbols

Washing







-  Cottons 95°C
-  Cottons 60°C
-  Cottons 40°C
-  Minimum iron 60°C
-  Minimum iron 40°C
-  Minimum iron 30°C
-  Delicates 40°C
-  Delicates 30°C

Machine washable woollens



Use the special 'Wool' programme, and only wash textiles bearing the label shown here:







This symbol is registered by the IWS (International Wool Secretariat)

-  Hand wash
-  do not wash
-  dry clean
-  do not dry clean
-  suitable for chlorine bleach
-  do not use chlorine bleach





Tumble dry

-  at normal temperature
-  at low temperature
-  do not tumble dry

Ironing

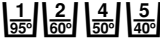
-  hot iron
-  medium hot iron
-  cool iron
-  do not iron

N.B. If you have any textiles with the older wash care labels, select a programme according to the label below.

- Cottons 
- Minimum iron 
- Delicates 
- Woollens 

Each of the following buttons can be pressed in to give an additional option.

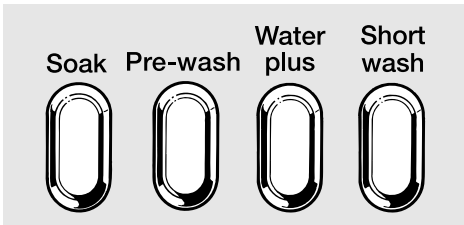

When the “Door” button is pushed in, all the other buttons spring out again, and the additional options are cancelled.

The following options are additionally available for certain wash programmes:

“Soak”

- For heavily soiled and stained items with dried on stains, or ones which can be bleached out, (e.g. blood, fats and oils, cocoa).
- Soak duration: 2 hours.



Amount of detergent for “Soak”

The amount of detergent recommended by the detergent manufacturers should be distributed according to the wash programme which is to be run after the “Soak” process.

– Programmes without pre-wash:

Add the total amount of detergent to compartment  or directly into the drum on top of the laundry.

– Programmes with pre-wash:

1/4 of the detergent should be added to compartment  for the soak and pre-wash, and 3/4 added to compartment  for the main wash.

Additional options

“With pre-wash”

- For heavily soiled and stained items.

“Water plus”

- This is recommended for particularly delicate fabrics, and
- if more water is required for dispensing the detergent.
- the water level increases in all sections of the programmes COTTONS, MINIMUM IRON and QUICK WASH 40°C.

“Short wash”

- The length of the main wash is shortened for lightly soiled items. An additional reduction in temperature is not recommended as this may lead to poorer wash results.
- In the COTTONS and MINIMUM IRON programmes only two rinse cycles are carried out at high water level.

Spin

The final spin speed is selected by turning the spin speed selector to the setting required, but also depends on the basic wash programme chosen.

“Without final spin”

Interim rinse and spin is carried out in the relevant programmes.

Washing is not spun after the final rinse, but the water is drained away, and the machine goes straight into the anti-crease stage.

“Rinse hold”

Interim rinse and spin is carried out in the relevant programmes.

At the end of the final rinse the washing remains suspended in water.

This helps to reduce the possibility of creasing, if the washing is left for some time before being taken out of the machine.

To continue the programme:

Turn the spin speed selector to the required setting.

The maximum spin speed is automatically limited according to the basic wash programme chosen.

Delay start

The start of a programme can be delayed from 30 minutes up to 9 hours 30 minutes.

N.B.:

The machine must be switched on and the indicator light “Delay start” flashing.

❶ Select time delay.

Press the “Delay start” pushbutton until the required delay period shows in the display.

Each press of the button increases the delay by 30 minutes.

❷ Turn the programme selector required programme.

The “Delay start” indicator light stays on constantly.

The display counts back in 1 minute steps. After the appropriate time has elapsed, the “Delay start” light will go out.

The “Time left” indicator light will come on and the time remaining in the programme selected will be shown.

Deleting “Delay start”

- Press the pushbutton when “9 h 30 mins” shows in the display.

Time left "h min"

Programme duration shows in hours and minutes, as soon as:

- the programme selector switch is set to the required programme
- the delay start period has elapsed.

After the programme has started, the time left display counts down in 1 minute intervals.

At the beginning of a programme, the duration of the programme for a full load will be displayed.

In the COTTONS programme, the type and volume of the wash will be monitored during the first water inlet phase. With a part load the time display shows a shorter time of up to 45 minutes.

Cleaning and care

Cleaning the washing machine

- Clean the casing with a mild non-abrasive detergent or soap and water. Wipe dry with a soft cloth.
- Clean the facia panel with a damp cloth and dry with a soft cloth.
- The drum can be cleaned using a suitable proprietary stainless steel cleaner.

Do not use abrasive cleaners, or glass or all purpose cleaners. These might cause damage to the plastic surfaces because of the chemicals they contain.

Detergent dispenser drawer

- Pull out the detergent dispenser drawer until a resistance is felt.

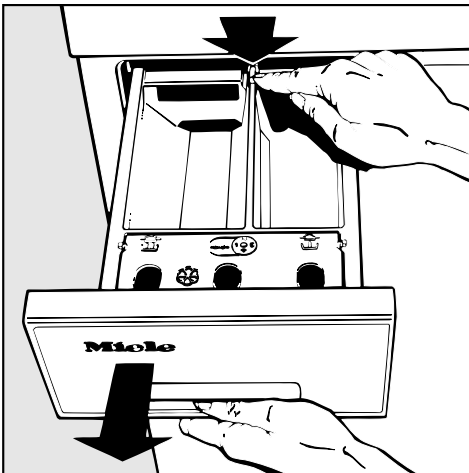

- Press down the red release knob and at the same time pull the drawer right out of the machine.

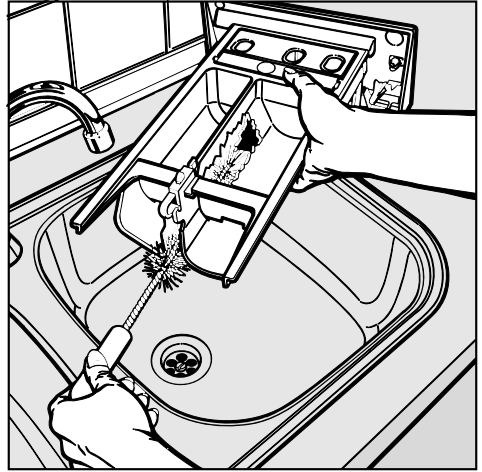

- Clean the detergent dispenser and conditioner dispenser compartments. Regularly remove any detergent residues.

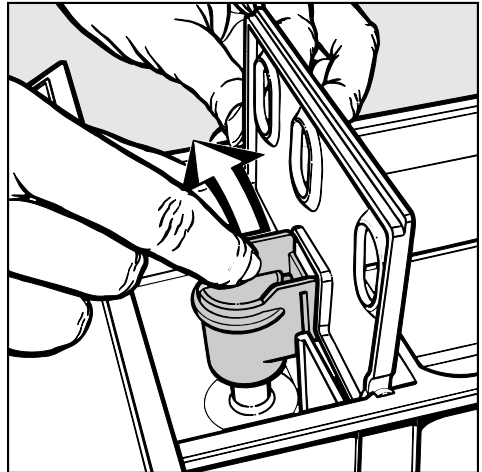

- Remove the suction tube from compartment , wash under running warm water and put back.

Cleaning the fluff filter and pump

Check the fluff filter initially after 3 - 4 washes to ascertain how often it is likely to require cleaning.

With normal cleaning approx. 2 litres of water run out.

If the drain outlet is clogged, more water will be retained in the machine (**up to 25 litres**).

Caution: if laundry has been washed at a high temperature, water draining out of the machine will still be hot!

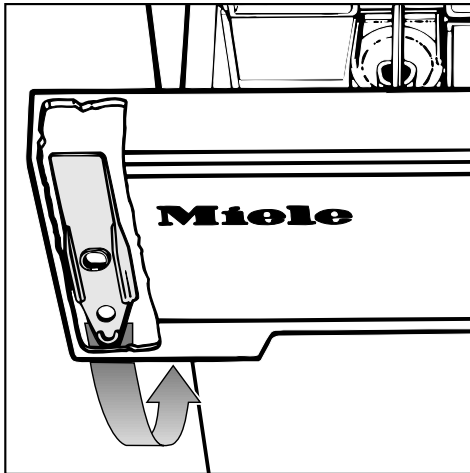

Take the (yellow) filter flap opener from behind the detergent drawer facia panel, (see illustration above).

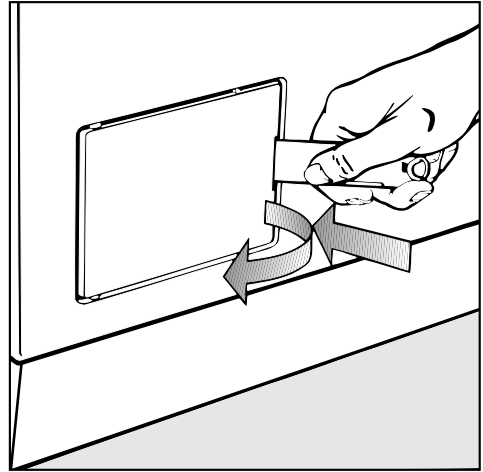

- Open the flap
- Place a dish under the drain fixture.

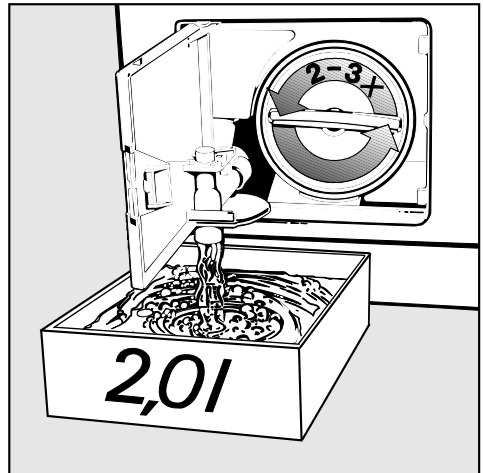

- Turn the fluff filter lid round 2 - 3 times. **Do not** take it right out.

With large volumes of water when the dish is full, screw the fluff filter back into position and empty the dish before repeating the procedure.

Cleaning and care

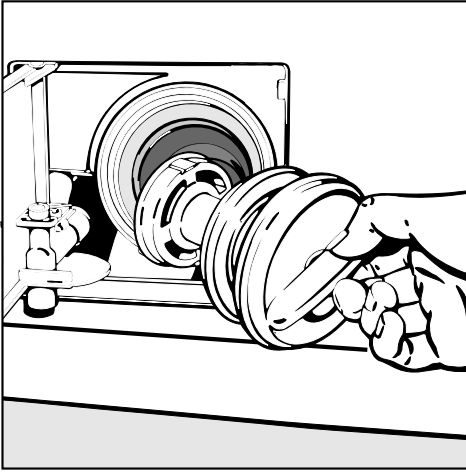

- Once the flow of water ceases, remove the fluff filter completely and clean it.
- Remove any foreign bodies (e.g. buttons, coins, etc.) and fluff.
- Turn the impeller by hand to check that it is free to rotate. Any foreign objects causing an obstruction should be removed.

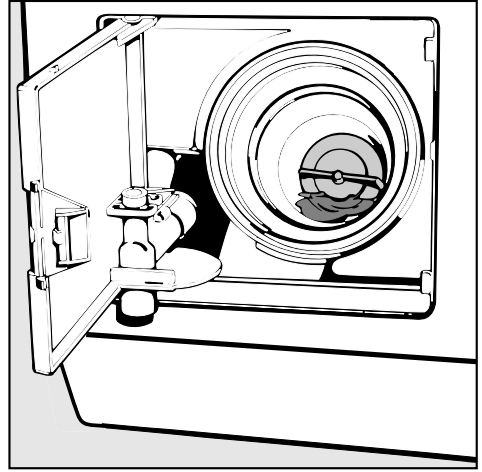

- Clean the inside of the fluff filter housing.

Remove any deposits of lime scale and detergent or foreign bodies from the thread of the filter housing and filter unit (as these objects can cause a leakage of water).

- Put the fluff filter back and screw it in firmly.

Cleaning the filter in the water inlet

The washing machine has two filters to protect the water inlet valves.

The accessible filter in the union in the open end of the inlet hose should be cleaned about every six months, or after an interruption to the external water supply.

- First turn off the stopcock.
- Unscrew the threaded union connecting the free end of the inlet hose to the stopcock.



- Remove the rubber seal from the recess.
- Using pointed pliers, take hold of the plastic filter bar, remove the filter and clean.
- Put the filter and seal back in the reverse order and reconnect the hose.

Turn on the stopcock and check the connection is water tight. If water drips out, tighten the connection.

Never forget to put the filter back in place after cleaning it.

Problem solving guide

Repair work to electrical appliances should only be carried out by a suitably qualified person in accordance with local and national regulations. Unauthorised repairs could be dangerous.

What to do if . . .	Cause . . .	Remedy . . .
<p>. . . the programme does not begin:</p>	<p>There is no power. The "ON" indicator light has not lit up.</p>	<p>Check that:</p> <ul style="list-style-type: none"> – the door is properly closed. – the plug is plugged in, and the socket switch is on. – the fuse or circuit breaker has not tripped.
	<p>There is power and the "ON" indicator is lit up, but the programme selector has not been turned to the "Finish / Start" position.</p>	<ul style="list-style-type: none"> – Turn the programme selector the "Finish / Start" position. – Select a programme.
<p>. . . the "Check water inlet / outlet" indicator lights are flashing:</p>	<p>The water inlet is blocked. The "Check water inlet" light is flashing, but the programme has run normally.</p>	<ul style="list-style-type: none"> – The stopcock is not opened far enough. – The inlet hose is kinked. – The water pressure is too low. Call the Service dept.
	<p>The water inlet system is blocked. The "Check water inlet" light is flashing, and the "Finish" light is on in the display sequence, but the load in the machine has not been washed.</p>	<ul style="list-style-type: none"> – Turn the programme selector to "Finish / Start". – Open the stopcock. – Select a programme.
	<p>The water outlet is blocked. The "Check water outlet" light is flashing.</p>	<ul style="list-style-type: none"> – Clean the fluff filter and drain pump. – Has the drain pump been fitted too high? (max, drain head 1 metre).
	<p>The Waterproof-System has reacted. The "Check water inlet / outlet" lights are flashing.</p>	<p>Call the Service dept.</p>

Problem solving guide

What to do if, . . .	Cause . . .	Remedy . . .
<p>. . . one of the following lights is flashing:</p> <ul style="list-style-type: none"> – “Soak / Pre-wash” – “Main wash” – “Rinses 1 - 2 – “Rinse 3 	<p>There is a fault.</p>	<p>Start the programme again. If the light starts flashing again, call the Service dept.</p>
<p>. . . the “Rinse hold” light flashes?</p>	<p>The spin speed selector has been set to “Rinse hold”.</p>	<p>Select a spin speed setting (or Without final spin).</p>
<p>. . . the “Final spin” light is flashing:</p>	<p>The final spin has not taken place The machine detected an imbalance.</p>	<ul style="list-style-type: none"> – Loosen the laundry load. – Turn the programme selector to “Spin”. – The spin speed appropriate for the programme should be selected.
<p>. . . the “ON” indicator light is flashing:</p>	<p>Programme locking is activated. There was an attempt to alter the programme.</p>	<p>Reselect the programme originally chosen.</p>
<p>. . . the washing is not spun satisfactorily:</p>	<p>The spin speed selected was too low.</p>	<p>Select a higher spin speed next time.</p>
	<p>The load was not distributed sufficiently evenly in the drum. Laundry was spun at a reduced speed to protect the machine.</p>	<p>Mix large and small items in a load to avoid imbalance.</p>
	<p>The fluff filter is clogged.</p>	<p>Clean the fluff filter.</p>
<p>. . . the machine shakes during the spin cycle:</p>	<p>The four feet are not resting evenly on the floor.</p>	<p>Level the machine (See Section on Installation).</p>
<p>. . . the light rings do not illuminate:</p>	<p>The bulb has gone. (This in no way affects the machine's function).</p>	<p>Changing the bulb requires a Service call.</p>
<p>. . . in spite of adequate water supply the water flows slowly into the machine:</p>	<p>The filter in the water inlet system is blocked.</p>	<p>Clean the water inlet filter.</p>

Problem solving guide

What to do if . . .	Cause . . .	Remedy . . .
<p>. . . the drum door cannot be opened.</p>	<p>The appliance is not plugged in to the electricity supply.</p>	<ul style="list-style-type: none"> – Put the plug in the socket.
	<p>Power cut</p>	<ul style="list-style-type: none"> – See “What to do if” - (1st Section) on how to open the door.
	<p>The door was not correctly engaged.</p>	<ul style="list-style-type: none"> – Please press hard against the lock side of the drum door and then press the “Door” button.
	<p>There is still water in the drum.</p>	<ul style="list-style-type: none"> – Select the “Drain” programme for the water to be pumped out. – Open the drum door
	<p>The suds temperature is higher than 55°C.</p>	
<p>. . . large residues of detergent remain in the dispenser drawer:</p>	<p>The water supply pressure is too low.</p>	<ul style="list-style-type: none"> – Clean the water inlet filter. – It may be useful to select “Water plus”.
	<p>Washing powder used with water softener tends to become sticky.</p>	<p>Pour washing powder into the dispenser before adding the water softener.</p>
<p>. . . fabric conditioner is not completely dispensed or water remains in the  compartment:</p>	<p>The dispenser drawer was not pushed right in when the conditioner was being flushed in.</p>	
	<p>The siphon tube is either incorrectly positioned or clogged.</p>	<p>Clean the siphon tube.</p>
<p>. . . there is an excessive build-up of foam:</p>	<p>Too much detergent was used. Use only a suitable low-lather detergent at the appropriate temperature.</p>	<ul style="list-style-type: none"> – Follow recommendations on the packet. – Take the water hardness level in account. – Use less detergent for lightly soiled or small loads.

Problem solving guide

What to do if . . .	Cause . . .	Remedy . . .
. . . lime deposits appear on the drum surface:	Not enough detergent has been used.	<ul style="list-style-type: none"> – Use a descaling agent which must be stated by the manufacturer to be suitable for use in washing machines. – Use the correct amount of detergent to cope with the water hardness
. . . grey, greasy particles cling to washed laundry:	Insufficient amounts of detergent were used to break down the particles of grease in heavily soiled laundry.	<ul style="list-style-type: none"> – Either add more detergent, or use liquid detergent. – Before washing the next load run a COTTONS 60°C programme with liquid detergent but without a load to clean the machine.
. . . there are white residues which look like powder detergent on the washing:	The detergent contained compounds (zeolites) to aid water softening which are not soluble in water. These have ended up on the textiles.	<ul style="list-style-type: none"> – Use detergents containing no zeolites to re-wash the load, and in the future. Liquid detergents usually contain no zeolites. – Try and brush off the residues with a soft brush.
. . . liquid detergent does not give the desired result:	Liquid detergents do not usually remove stains such as fruit juice, tea, coffee, wine etc.	<ul style="list-style-type: none"> – Use a general purpose washing powder containing a bleaching agent, (check first with the care label). – Pour stain remover (salts) into the dispenser drawer compartment III Put the liquid detergent into a dispenser ball. – Never put stain salts and liquid detergent together in the dispenser drawer.
. . . The pump makes strange noises.	These noises occur at the end of a pump sequence as a normal part of the operation. They are not a fault.	

Problem solving guide

Opening the drum door in the event of a power failure

- Switch off the washing machine.
- Open the drain pump/fluff filter panel and drain off any water as described in the Section on Cleaning and care.

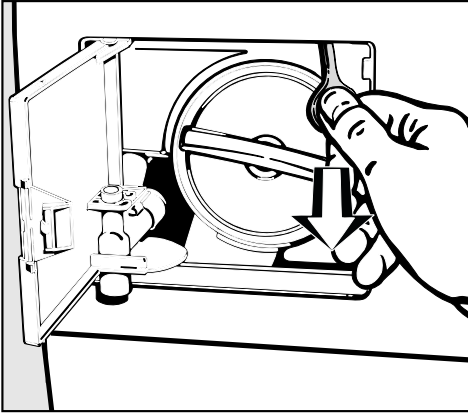

- Pull the ring of the door mechanism downwards, the door will open.

Always make sure that the drum is stationary before reaching in to remove washing. Reaching into a moving drum is extremely dangerous.

To check water pressure

- Place a bucket under the stopcock.
- Turn on the stopcock.

If 5 litres of water flow into the bucket in 15 seconds the water pressure is correct.

Electric socket

- If there is any doubt about the electricity supply socket, consult a qualified electrician.

In the event of any faults which you can not remedy yourself, please contact:

- Your Miele Dealer or
- Your nearest Miele Service department.

(see back cover for the address).

When contacting the Service Department, please quote the Model and Serial nos. of your appliance, both of which are shown on the data plate visible when the door is opened above the porthole glass.

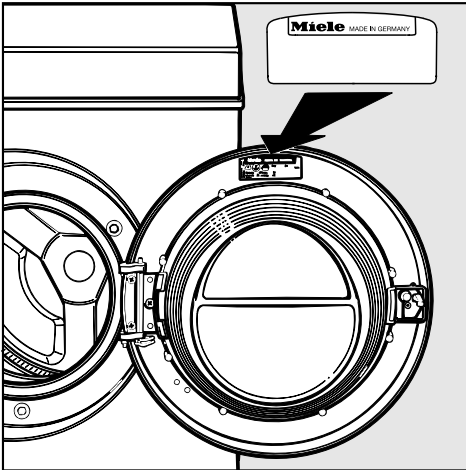

Example:



Future updates

The indicator light marked PC is reserved for the service engineer, for updates in future years to your machine.

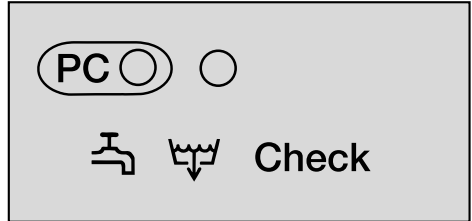

When for example technological developments offer advanced modifications to your existing programme cycles, a service engineer will be able to input these into your machine controls.

Miele will provide information when such possibilities become available.

Installation

Installation surface

Experience has shown that a concrete floor is the most suitable installation surface for a washing machine. Concrete floors are far less prone to vibration during the spin cycle than wooden floorboards or a surface with "soft" properties.

Please note the following points:

- The machine must be level and securely positioned.
- To avoid vibrations during spinning, the machine should not be installed on soft floor coverings.
- If installation must be on a wooden joist floor, we recommend the use of a plywood base at least 30 mm thick and 59 x 52 cm wide. Ideally, the base should be large enough to span several joists and should be bolted to the joists and not only to the floorboards. Check for the presence of pipes and cables first.

The most stable part of a floor is usually in the corner.

If the machine is installed on a raised plinth, it **must** be secured against slippage during spin using retaining clips (available from the Miele Spare Parts Dept).

Installation

Lift the machine from its packaging base and move it to its site. Please note:

- Do not lift the machine by the drum door.

- Ensure that the machine feet and the floor are dry to prevent the machine from slipping during the spin cycle.

Removing the transit fitting

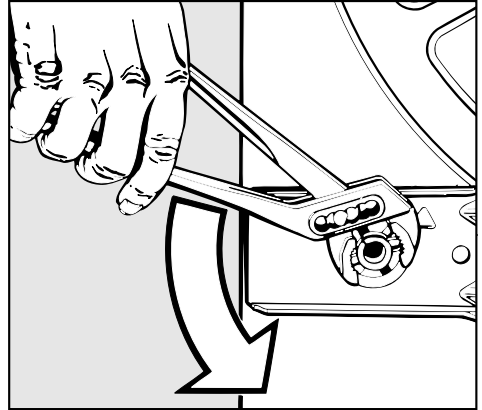

- Using a pipe wrench turn the left-hand transit bar 90°.

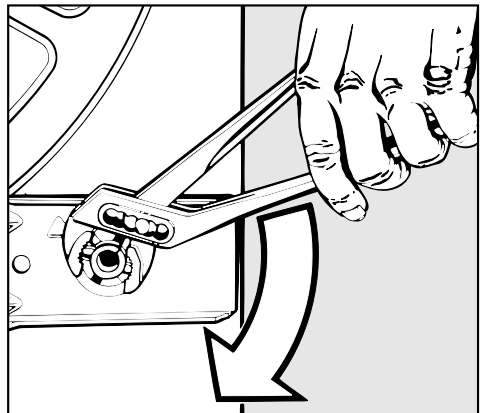

- Turn the right-hand transit bar 90°.

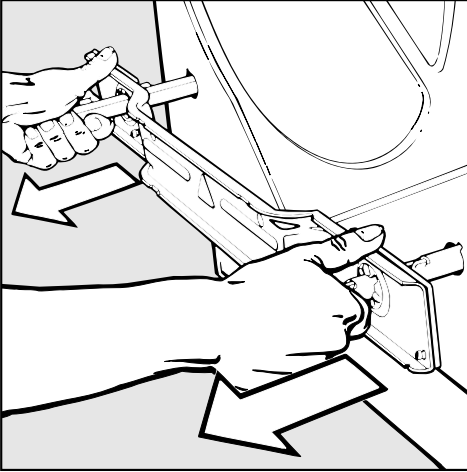

- Withdraw the two bars together with the support plate.

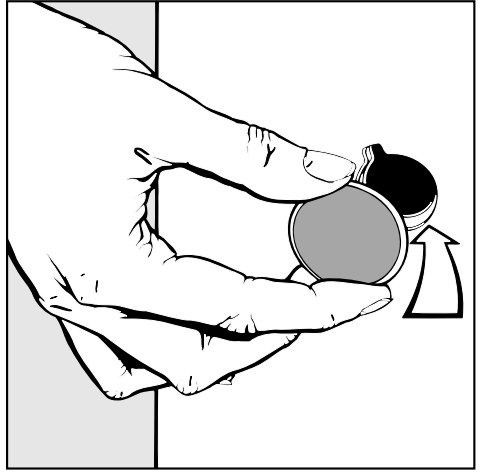

- Plug the two holes with the plastic caps supplied.

The machine should not be moved without the transit fitting in place.

The transit fitting should be stored in a safe place for future use. It must be re-fitted if the machine is to be moved again. Re-fitting is carried out by reversing the procedure.

Installation

Levelling the machine

The machine must be perfectly level to ensure safe and proper operation.

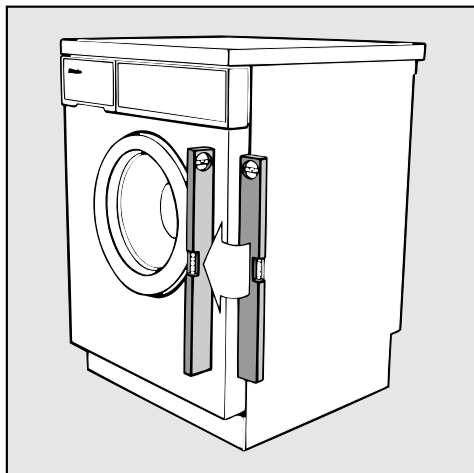

Incorrect installation may increase water and electricity consumption.

The screw feet can be adjusted to level the machine:

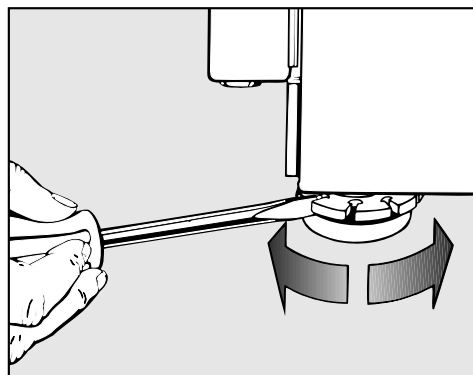

- Unscrew the foot or feet until the machine stands level.
- Hold the foot tight using a pipe wrench.

- Tighten the counternut using a screwdriver as indicated.

Building under

To install this appliance under a (continuous) worktop:

- A special conversion kit* is required.
- The machine lid must be replaced by a cover plate.
To ensure electrical safety the cover plate must be fitted by a suitably competent person exactly according to the fitting instructions included with the kit.
- For installation under a work surface 900/910 mm from the floor, a raising kit* is required.
- Connections for electricity, water and drainage should be installed in such a way that they remain accessible when the machine is in place.

Relevant fitting instructions are supplied with each kit.

Washer-Dryer stack

A Miele tumble dryer can be stacked with this washing machine. A stacking kit* is necessary.

All parts marked * are available from the Miele Spare parts or Sales Department, and from some Miele Dealers.

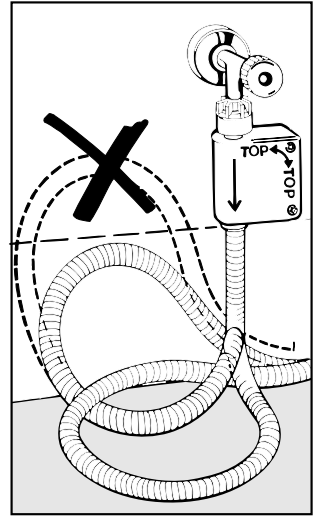
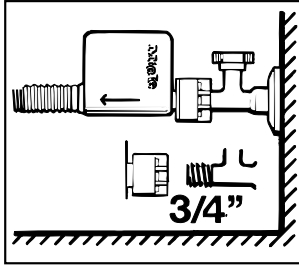
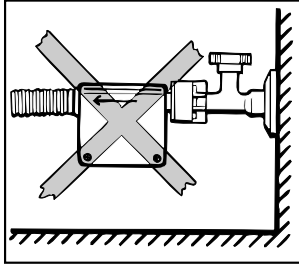
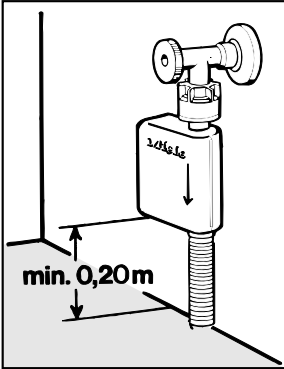

Connection to water supply

Fitting

The machine should be connected to a mains water supply in accordance with standard regulations. The German authorities do not require it to have a non-return valve as the washing machine has been designed to comply with DVGW regulations (German Association of Gas and Water Engineers, see data plate).

The machine is designed to operate with a minimum water pressure of 1 bar. There is a minimum flow pressure of 1 bar if 5 litres of water flow into a suitable container in 15 seconds.

The static water pressure must not exceed 10 bar. If it is higher than 10 bar it is essential to fit a reducer valve.

The **Miele "Waterproof system"** connected between the stopcock and the

machine offers the safest protection against water leaks.

For the "Waterproof system" to function correctly, it may only be fitted in the positions shown (see illustrations).

Connection to the mains water supply should incorporate a mains stopcock with 3/4" thread. The stopcock should be fitted by a qualified plumber.

Plumbing

The connection point is subject to mains water pressure. Turn on the stopcock slowly and check for leaks. Correct the position of the washer and union if appropriate.

The "Waterproof system" is **NOT** suitable for connection to a hot water supply.

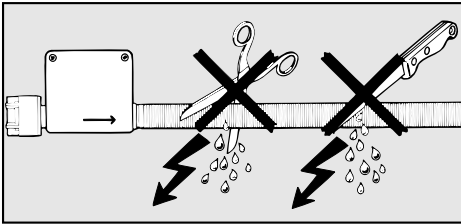

The protective sleeve of the hose **must not be damaged** (see illustration).

The "Waterproof system" with a hose length of approx. 4.5 metres is available as an optional extra.

Function

At the heart of this leak protection system there is an **electric safety valve**, which works like an automatic stopcock. The Miele "Waterproof system" protects from water damage in the following cases:

Protection in the event of a leaking machine

Any leaking water is collected in a sump in the base of the appliance. A float switch switches the safety valve off electrically, no more water will flow in.

Protection in the event of a leaking water inlet hose

Leaking water is fed into the sump through the protective covering which surrounds the inlet hose as a "second skin". The float switch switches off the water supply.

Maintenance

NB. If you intend to unscrew the "Waterproof system" unit from the mains water supply it is essential that the machine is first disconnected from the electricity supply.

Only use a genuine Miele "Waterproof system" able to withstand pressure of up to 70 bar, should you ever need a replacement.

In order to protect the water inlet valves the dirt filter in the solenoid safety valve connection must not be removed.

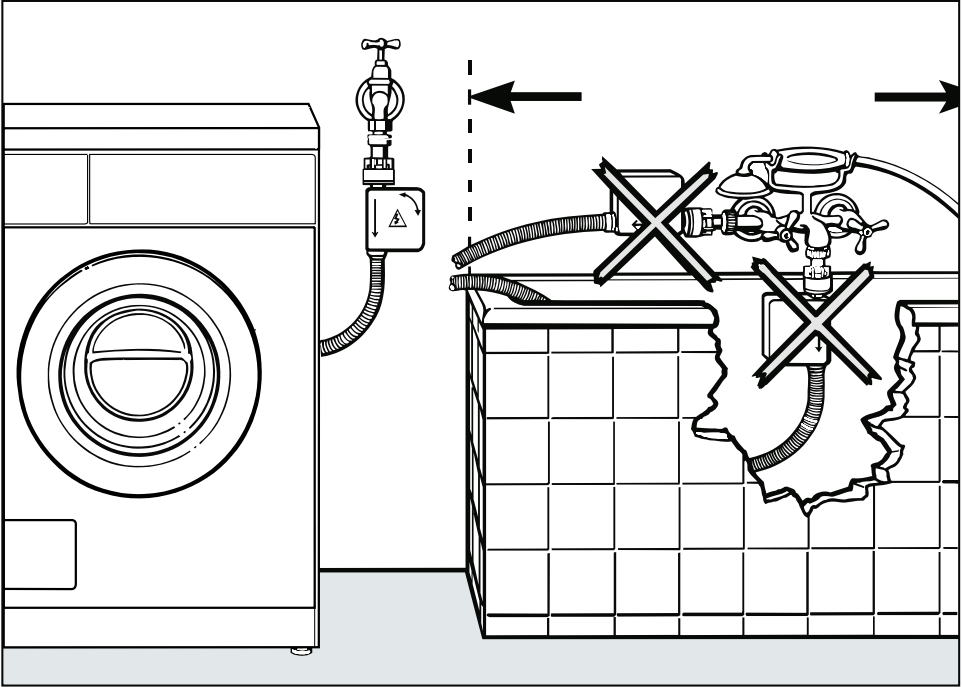

not be connected to mixer taps or similar.

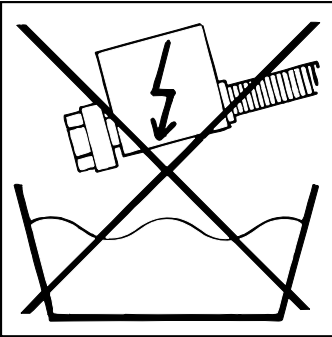

Important!

The plastic casing of the water connection contains an electric component.

Do not dip it into liquids!

The "Waterproof system" must only be connected to its own stopcock. It must

Plumbing

Connection to the drainage system

The machine drains via a drain pump with a delivery head of 1 metre.

The drain hose is 1.5 m long. It must not be kinked as this restricts drainage. The swivel elbow at the end of the hose can be turned in either direction, or can be detached if required with a sharp twist and pull.

Drain hose connection:

- Direct into a sink: Hook the hose over the edge and secure. Make sure that the water can flow freely to avoid flooding and to prevent water from being sucked back into the machine.
- Connected to a standpipe.
- Connected to a plastic drain pipe with a rubber nipple. There is no need to use a non-return valve.
- Allow the water to drain off into a floor drain.

If required, the hose can be extended to a length of 5 m. The necessary parts can be purchased from the Miele Spare Parts department.

For a delivery head of more than 1 m (up to a maximum of 1.8 m) a second Duo drain pump is available with the corresponding conversion kit from the Miele Spare Parts Department.

This machine is supplied ready for connection to an a.c. single phase 230 - 240 V, 50 Hz supply. The machine is supplied with a 2 m long mains cable with moulded plug. The voltage, rated load and fuse rating are given on the data plate. Please ensure that these match the household mains supply.

All electrical work should only be carried out by a suitably competent person, in accordance with national and local safety regulations.

Connection should be made via a fused plug and a suitable switched socket which is easily accessible. For extra safety it is advisable to install a residual current device (RCD) with a trip current of 30 mA.

Important

The wires in the mains lead are coloured in accordance with the following code:

Green/yellow = earth

Blue = neutral

Brown = live

As the colours of the wires in the mains lead of this appliance may not correspond with the coloured markings identifying the terminals in your plug, proceed as follows:

The wire which is coloured green and yellow must be connected to the terminal in the plug which is marked with the letter E or by the earth symbol \perp or coloured green or green and yellow.

The wire which is coloured blue must be connected to the terminal which is marked with the letter N or coloured black.

The wire which is coloured brown must be connected to the terminal which is marked with the letter L or coloured red.

WARNING

THIS APPLIANCE MUST BE EARTHED

Non-rewireable plugs BS 1363

If this machine or appliance is fitted with a non-rewireable plug, the following information applies:

If the socket outlets are not suitable for the plug supplied with this product, it must be cut off and an appropriate plug fitted.

The plug cut from the flexible cord should be disposed of and on no account be inserted into any socket elsewhere in the house (electric shock hazard).

The fuse cover must be refitted when changing the fuse, and if the fuse cover is lost, the plug must not be used until a suitable replacement is obtained. The colour of the correct replacement is that of the coloured insert in the base of the plug, or the colour that is embossed in words in the base of the plug (as applicable to the design of plug fitted). The correct fuse rating of the replacement fuses that are ASTA approved to BS 1362 should be fitted. Replacement fuse covers may be purchased from your local electrical suppliers, or Miele Service Agent.

Programmable functions - Selection

With the programmable functions you can adapt the machine to your individual requirements. A function stays programmed in memory until it is cancelled.

The following programmable functions are available:

A High water level

Where rinse results are particularly important.

Effective for the rinses in programmes:

- COTTONS
- MINIMUM IRON
- QUICK WASH 40°C

B Extra rinse for Cottons programmes

For soft water areas (water hardness range 1).

Where rinse results are particularly important in soft water areas an extra rinse can be selected as well as high water level.

C Programme Lock (Child safety feature)

Programme lock prevents:

- a wash programme being changed into another
- unplanned opening of the door
- altering the additional functions set for example by playing children.

The washing machine ignores any changes after the first three minutes of starting the programme, for example if the programme selector switch is set to a different setting or an additional programme is selected.

- The “On” light starts flashing

Once the programme selector switch is turned back to its original position the “On” light stops flashing.

To cancel a programme for which the lock has been programmed:

- Turn the programme selector switch to “Finish/Start”.

The programme sequence indicator lamps start flashing in succession after approx. 30 seconds.

You can select a different programme as soon as only the “On” light lights up.

D Gentle action

For gentle washing of slightly soiled items. Drum movement is reduced.

The “Gentle action” function is available for COTTONS, MINIMUM IRON and QUICK WASH 40°C.

Activating the programmable functions is described on the following pages.

Programmable functions - To programme

Programming and saving the programmable functions

Programmable functions are activated using a combination of the buttons for the optional functions with the programme selector switch. These combinations can call up extra functions not displayed on the control panel.'

Programming takes place in three steps:

- select programming mode
- activate programmable function
- store programmable function in memory

1. Select programming mode

- ➊ The machine must be switched off and the door closed. All pushbutton switches must be released and programme selector pointing to "Finish / Start".
- ➋ Press in the "Soak" and "Short wash" buttons.
- ➌ Press in the "I-ON / O-OFF" button.
- ➍ Release the "SOAK" button.
- ➎ Release the "Short wash" button.

The "ON" light now comes on in the sequence display and the "Main wash" light flashes.

2. Activate programmable function

- ➏ For the function required turn the programme selector to the appropriate setting as follows:
 - for High Water Level programmable function **A** turn to SEPARATE RINSE
 - for Extra rinse programmable function **B** turn to Drain
 - for Programme lock programmable function **C** turn to QUICKWASH 40°C
 - for Gentle action programmable function **D** turn to DELICATES 50°C

The indicator light "Rinses 1-2" now lights up in the sequence display.

- ➐ Quickly press the "Short wash" button 4 times, (eg in and out twice).

The indicator light "Rinses 1-2" now lights up in the sequence display.

The programmable function is now activated.

- ➑ If you wish to activate more than one programmable function, repeat steps 6 and 7. If not, then:

3. Save the programmable function

- ➒ Press the I-ON /O-OFF button to release it.

The machine is now switched off and the programmable function(s) stored in memory.

Programmable functions - Check/Cancel

To check the programmable function:

To see if a selected programmable function has been activated, carry out Steps ❶ to ❹.

- If the “Rinses 1-2” light comes on , the relevant programmable function is activated.

■ Press the I-ON / 0-OFF button.

This finishes the check.

To cancel the programmable function:

Repeat the steps ❶ to ❹.

- In step ❷ the “Rinses 1-2” light now goes out.
- In step ❹ (Press the I-ON / 0-OFF button) the programmable function is cancelled.

Consumption data

Normal Programmes (without any additional options or programmable functions)	Load	Consumption data			
		Electricity in kWh	Water litres	Time	
				normal	short wash
Cottons 95°C	5.0 kg	1.75	61	1 h 52 mins	1 h 23 mins
Cottons 60°C*	5.0 kg	1.00	58	1 h 51 mins	1 h 12 mins
Cottons 40°C	5.0 kg	0.50	58	1 h 35 mins	1 h 02 mins
Minimum iron 40°C	2.5 kg	0.45	65	1 h 20 mins	43 mins
Delicates 30°C	1.0 kg	0.40	75	1 h 00 mins	41 mins
Woollens 30°C	1.0 kg	0.20	60	46 mins	–
Starch	5.0 kg	–	–	19 mins	

* according to Standard: DIN EN 60456

Consumption data can vary from the nominal values given as a result of water pressure, water hardness, water inlet temperature, room temperature, type of load, volume, fluctuations in the electricity supply and any additional options or functions selected.

Technical data

Height	85 cm
Width	59.5 cm
Depth	60 cm
Depth with door open	97 cm
Weight	103 kg
Max. floor load	1600 Newton (approx. 160 kg)
Capacity	5 kg dry laundry
Voltage	
Rated load	}see Data plate
Fuse rating	
Water flow pressure min.	1 bar
Static water pressure max.	10 bar
Drain pump head max.	1 m
Drain pump length max.	5 m
Test certificates awarded	Radio/tv suppression, VDE
Electrically suppressed according to . .	DIN EN 60555/VDE 0838

Miele

United Kingdom

Miele Co. Ltd.

Fairacres, Marcham Road, Abingdon, Oxon, OX14 1TW

tel. Abingdon (01235) 554455 - fax (01235) 554477

Service Office, tel. Abingdon (01235) 554466

Ireland:

Miele Ireland Ltd.

Wilton House, Naas Road, Dublin 22

Tel. (01) 4504024, Fax (01) 4504037